

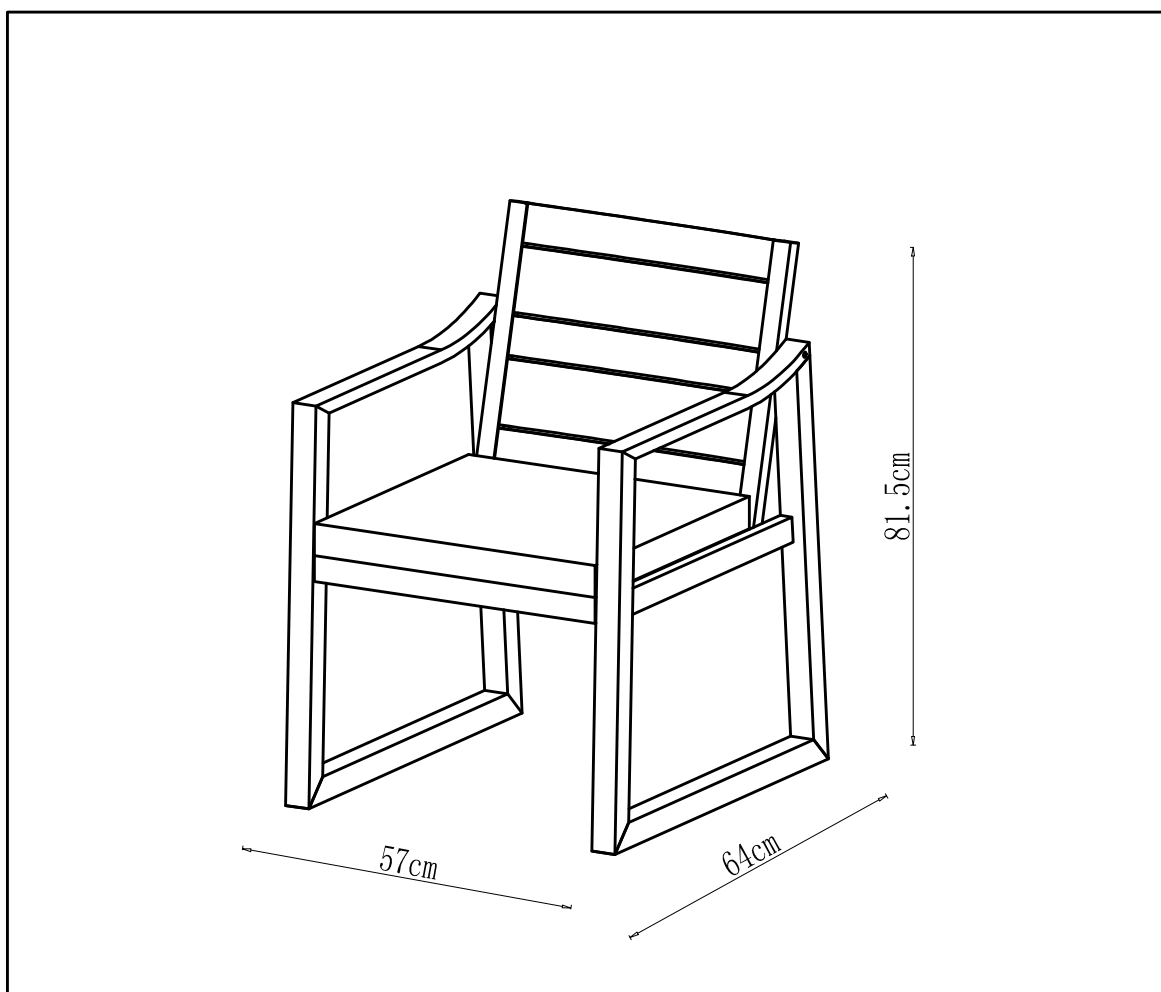

ASSEMBLY INSTRUCTION
ZARIAH - OUTDOOR DINING CHAIR

ITEM CODE - 72303

Imported by Amart Furniture Pty Ltd, Qld, Brisbane Australia .
For any assistance with assembly or for missing parts please phone
Amart Furniture ,Customer Service Freecall 1800 351 084



Imported by Amart Furniture Pty Ltd, Qld, Brisbane Australia .
For any assistance with assembly or for missing parts please phone
Amart Furniture, Customer Service Freecall 1800 351 084

PRE-ASSEMBLY PREPARATION



Before you start:

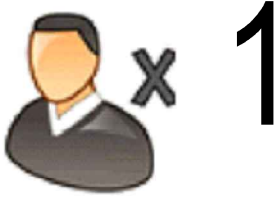



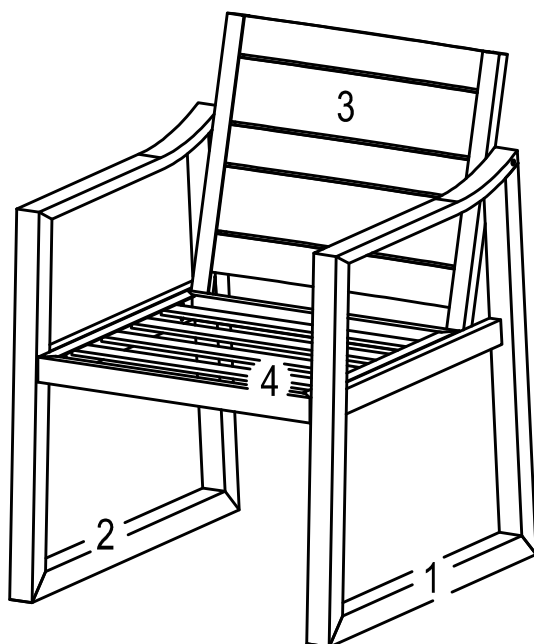

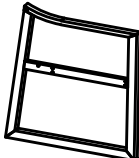
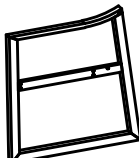
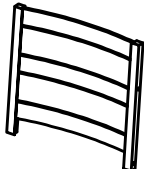
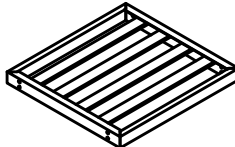
1. Choose a clean, level, spacious assembly area. Avoid hard surfaces that may damage the product.
2. Take care when lifting. Product should be assembled as near as possible to the point of use.
3. Ensure that you have all required contents for complete assembly.
4. Always read the assembly instructions carefully before beginning assembly.
5. Keep all hardware parts and packaging out of reach of small children.
6. Do not over tighten the screws and bolts as this may damage the threads.

	
ALLOW 20 MINUTES	PEOPLE REQUIRED
ADDITIONAL TOOLS REQUIRED	

PARTS LIST



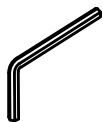



1. Left arm  1PC	2. Right arm  1PC
3. Backrest  1PC	4. Seat  1PC
5. Cushion  1PC	

A. Bolt  M6*35*8PCS	B. Bolt  M6*40*2PCS	C. Bolt  M6*55*2PCS	D. Shim  M6*12PCS
E. Hexagon Key  M6*1PC	F. Protective pad  4PCS		

Step 1:

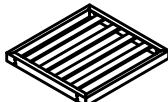
ITEMS REQUIRED

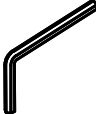

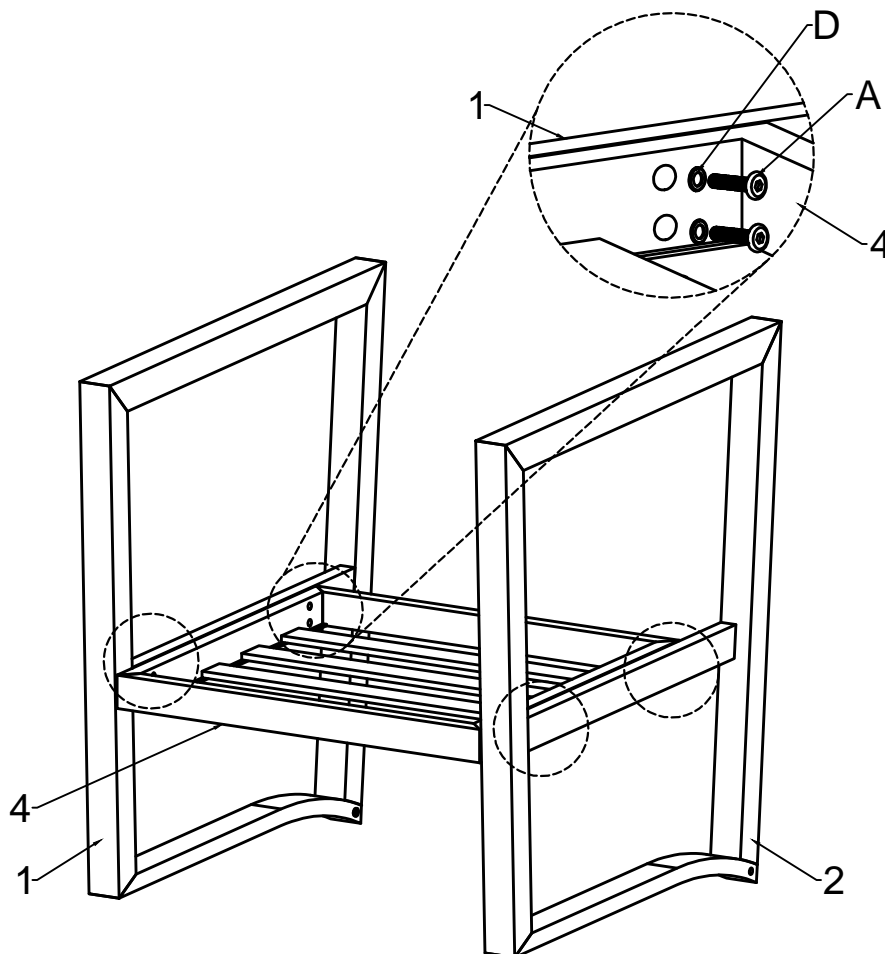

1. Left arm 1PC 	2. Right arm 1PC 	4. Seat 1PC 
A. Bolt  M6*35*8PCS	D. Shim  M6*8PCS	E. Hexagon Key  M6*1PC

- Attach left arm (1) and right arm (2) to seat (4) using bolt (A) with shim (D) .
- Insert all bolts before fully tightening .
- Tighten with hexagon key (E) .



Step 2:

ITEMS REQUIRED

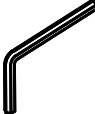
3. Backrest 1PC 			
B. Bolt  M6*40*2PCS	C. Bolt  M6*55*2PCS	D. Shim  M6*4PCS	E. Hexagon Key  M6*1PC

- Attach backrest (3) to left arm (1) and right arm (2) using bolt (B) &(C)with shim (D) .
- Insert all bolts before fully tightening .
- Tighten with hexagon key (E) .

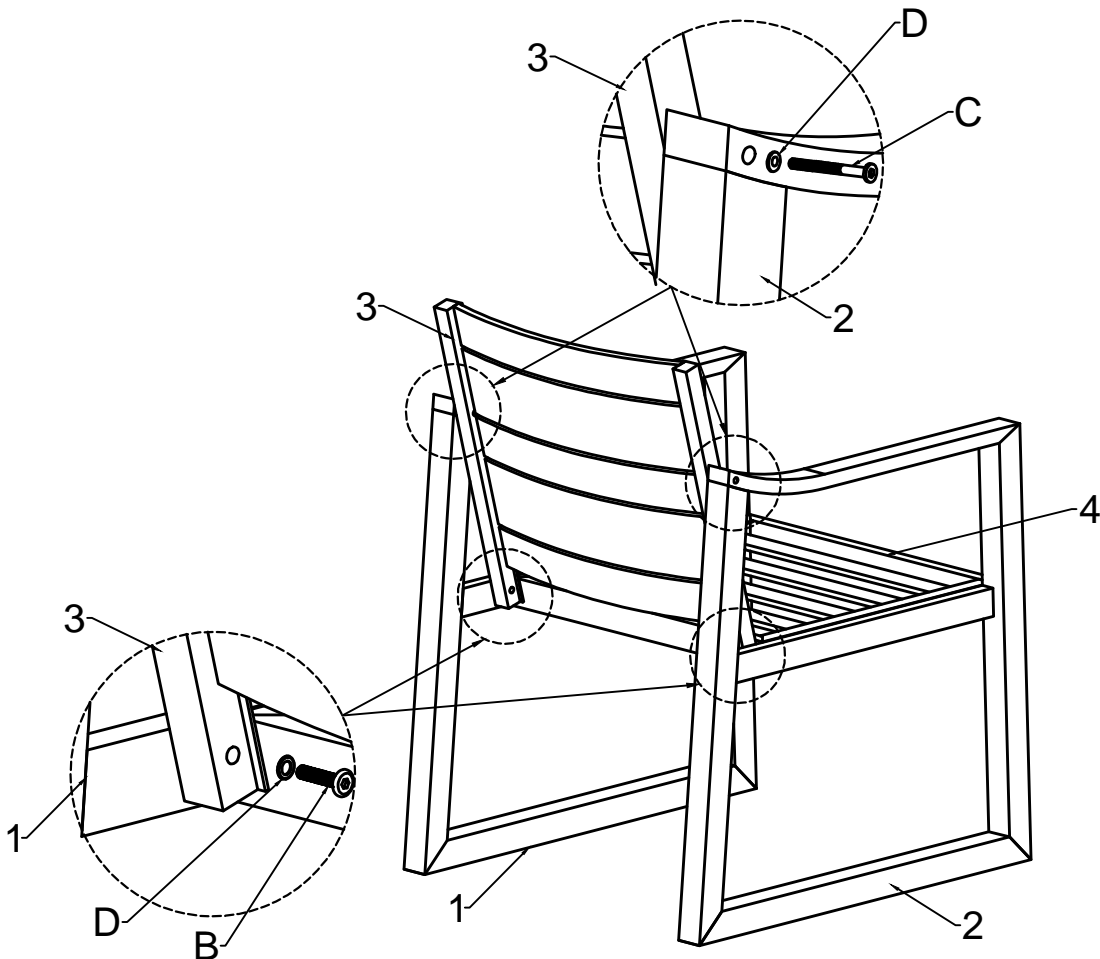

Step 3:

ITEMS REQUIRED

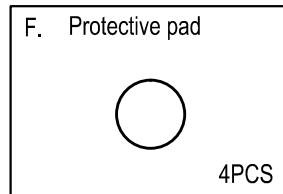

- Last attach the Protective pad (F) under the adjusting knob.

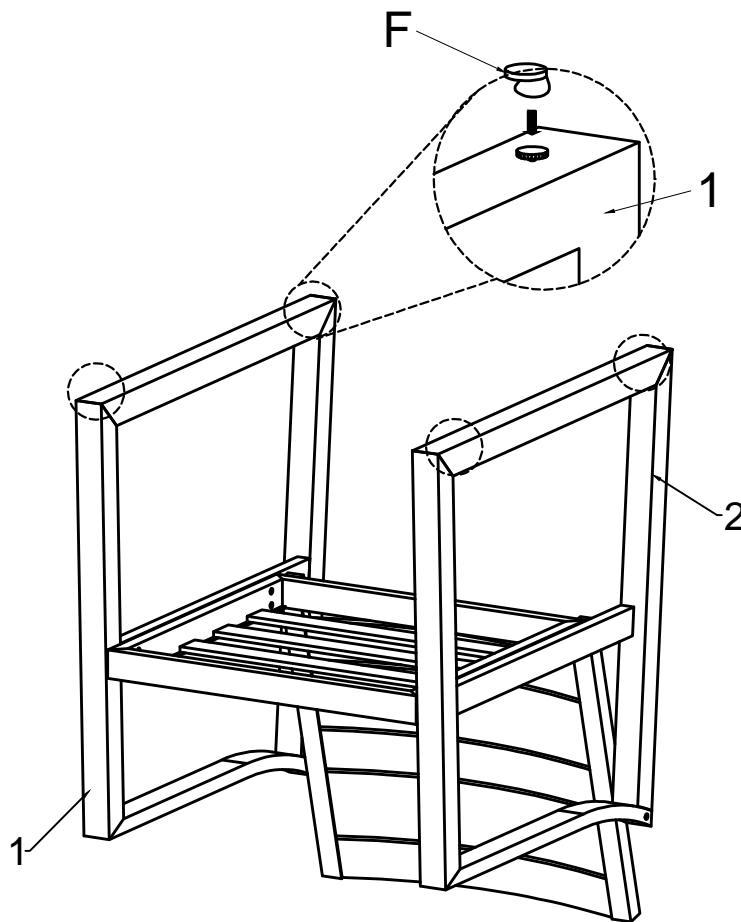

ASSEMBLY IS COMPLETE

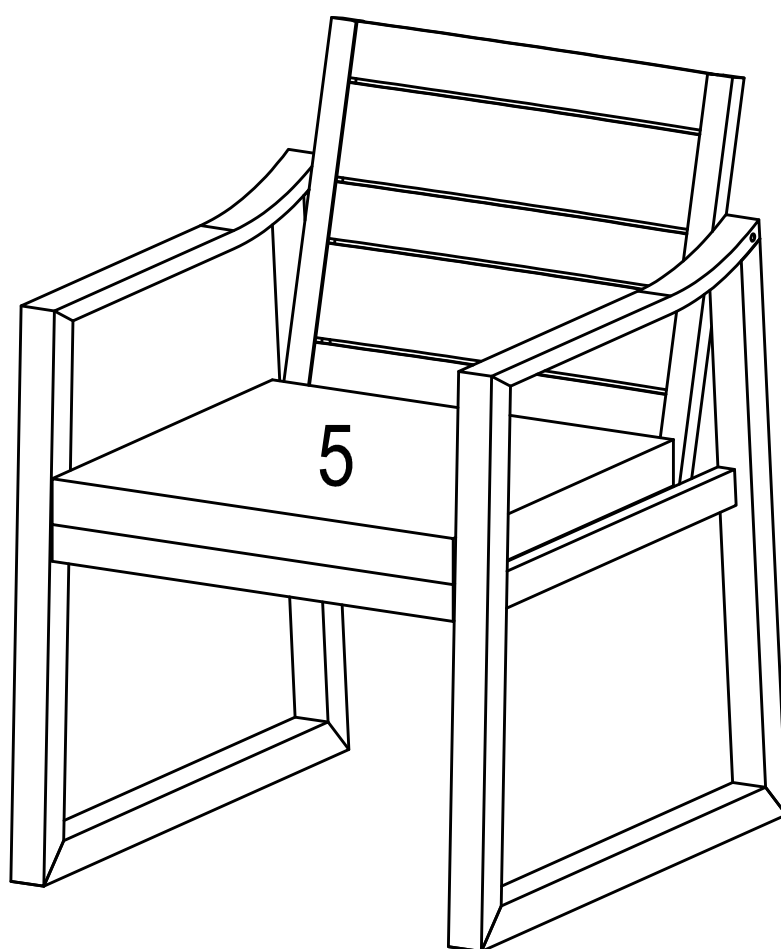

Care and maintenance



Cushions

- Direct exposure to the Sun's harmful UV rays is likely to cause rapid colour fading to fabrics. For best results we recommend avoiding exposure to direct sunlight
- To ensure product longevity it is recommended outdoor products are not left permanently exposed to the elements
- Spot clean using mild detergent and damp cloth. Dry flat in shade
- Do not unzip
- Do not put in washing machine
- Do not tumble dry
- Do not bleach
- Do not dry clean
- Cool iron only

Aluminium

- Item is designed for use outdoors. However we do not recommend leaving this product outside when not in use. To preserve the life of this item, avoid prolonged exposure to the elements & store inside/under cover or use an outdoor cover.
- DO NOT allow the furniture to be left in the rain or left wet for extended periods of time.
- Wipe furniture Dry immediately after it becoming wet.
- DO NOT clean your furniture down with any harsh solvents, abrasives or chemicals.
- To remove dirt and grime, simply rinse with fresh water or periodically clean using a sponge and mild detergent solution as required

Warning

Do not:

- Use chair/stool as a ladder
- Climb on the chair/stool
- Stand on the foot-rest of the chair, as this could lead to unbalanced and overturning